

LONDONDERRY TOWN COUNCIL MEETING MINUTES

1 **July 10, 2017**

2
3 The Town Council meeting was held in the Moose Hill Council Chambers, Town Hall, 268B Mammoth
4 Road, Londonderry, NH.

5
6 Present: Chairman Tom Dolan; Councilors Ted Combes, Jim Butler and Joe Green; Town Manager Kevin
7 Smith; Executive Assistant Kirby Wade; Absent: Vice-Chairman John Farrell

8
9 **CALL TO ORDER**

10
11 Chairman Dolan called the Town Council special meeting to order. Chairman Dolan led the Pledge of
12 Allegiance. This was followed by a moment of silence for the men and women in uniform serving us here
13 and abroad.

14 **PUBLIC COMMENT**

15
16 Councilor Ted Combes made an announcement recognizing Nicolas Bryme from Troop 109. Combes
17 stated that he will be going to his Eagle Scout ceremony representing the Town Council. Bryme had made
18 a brand new fire warning sign at the fire station.

19
20 Chairman Dolan invited up NHDOT for an update on the 1-93 construction project. Public Works Director
21 Janusz Czyzowski gave a brief introduction. Wendy Johnson, 7 Hazen Drive, Concord, NH Project
22 Manager, gave us an update. Dan Premo, NHDOT, Design Consultant, was also presenting. Johnson went
23 over the progress of the project and some upcoming projects. [See attached PowerPoint].

24
25 Chairman Dolan introduced a representative from Stantec to give everyone a refresher on intersection
26 failures. Public Works Director Janusz Czyzowski stated that a while ago the Town Council asked if
27 someone can come and explain about the classification of intersections, the failure of intersections and it
28 was lately due to the construction project on Stonehenge. David Debaie with Stantec presented a
29 PowerPoint to the Council. Debaie presented a PowerPoint. See attached.

30
31 Town Manager Smith introduced Ian Hill with Parlinet to introduce and go over a presentation. Parlinet
32 is a brand new civic technology startup. It helps citizens understand and participate in their local
33 governments. Hill went over a new online notification and public comment tool for local and state
34 governments. See attached PowerPoint. Hill stated that he would like to try Parlinet free with Londonderry
35 to receive feedback. Hill stated that they would like the Town Councils approval to launch in a month.
36 The Council gave approval to move forward. It will increase citizen engagement in town government.

37
38 Chairman Dolan introduced Ann Chiampa with the Londonderry Historical Society to request approval
39 for a dendrochronology study to be done of c.1722, 24 Griffin Rd. Ann Chiampa, 28 Wedgewood Rd.,
40 presented. See attached information. Councilor Butler motioned that the Council grant the \$1,600 the
41 Historical Society if looking for for the study. Second by Councilor Combes. Chair votes 4-0-0.

LONDONDERRY TOWN COUNCIL MEETING MINUTES

42
43
44
45
46
47
48
49
50
51
52
53
54
55
56
57
58
59
60
61
62
63
64
65
66
67
68
69
70
71
72
73
74
75
76
77
78
79
80
81

Assistant Town Manager Lisa Drabik gave a brief update on the CART pilot program which started on July 1st and run for 90 days.

Deanna Mele, 8 Valley St, stated that she had spoken with Town Manager Smith and Assistant Town Manager Drabik about maybe the town taking the lead and not as an Ordinance but just as a suggestion that they water their town properties every other day. Once of the areas being talked about is West Rd. and the water being depleted from that are. If the town shows they are willing to do this, perhaps the residents will follow. Same with the commercial people. Chairman Dolan asked Smith to take the suggestion to the Recreation department.

There was no other public comment.

PUBLIC HEARING

OLD BUSINESS

NONE

NEW BUSINESS

Chairman Dolan introduced the Land Use Agreement between the Town of Londonderry and Cross Farms Development LLC. There has already been two public hearings on this item. Motion to approve the agreement made by Councilor Green and second by Councilor Combes. Chair votes 4-0-0.

Chairman Dolan introduced Order #2017-19, an Order relative to the withdrawal of the Cable Equipment Capital Reserve Fund. Finance Director Doug Smith presented. Smith stated that this is the ongoing agreement with the school district relative to the sharing of the money that flows to the town through the franchise agreement with Comcast for \$28,000 per year. Motion to approve Order #2017-19 made by Councilor Green and second by Councilor Combers. Chair votes 4-0-0.

Chairman Dolan introduced Order #2017-20, an Order relative to Expired Impact Fee refunds. This was presented by Doug Smith. Motion to approve Order #2017-20 made by Councilor Green and second by Councilor Combes. Chair votes 4-0-0.

BOARD/COMMITTEE APPOINTMENT/RE-APPOINTMENT

NONE

LONDONDERRY TOWN COUNCIL MEETING MINUTES

82
83
84
85
86
87
88
89
90
91
92
93
94
95
96
97
98
99
100
101
102

APPROVAL OF MINUTES

Approval of Town Council minutes from June 19, 2017 made by Councilor Combes and seconded by Councilor Green. Chair votes 4-0-0.

TOWN MANAGER REPORT

ASSISTANT TOWN MANAGER REPORT

Assistant Town Manager Drabik gave an update on the water situation. Drabik stated that she met with Derry Public Works Director and visited Derry's spigot. What Derry does they have a spigot where hydro seeders can come and hook up and they pay \$25 annual permit to be able to do it and they pay \$4 per one thousand dollars. Drabik stated anyone can use this system.

ADJOURNMENT

Motion to adjourn made by Councilor Green and second by Councilor Combes. Chair votes 4-0-0.

Notes and Tapes by:	Your name	Date: 07/10/2017
Minutes Typed by:	Kirby Wade	Date: 07/21/2017
Approved by:	Town Council	Date: 08/14/2017

Classification of Intersection Failure

HCM2010

HIGHWAY CAPACITY MANUAL

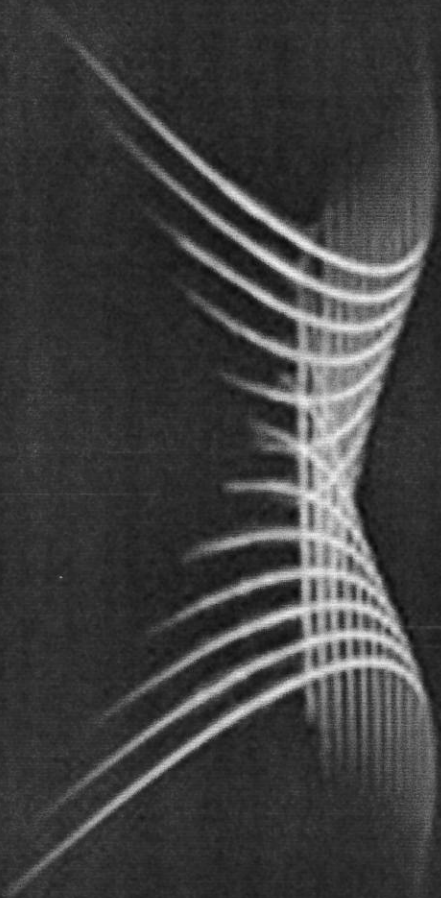

TORRE TRANSPORTATION RESEARCH BOARD
OF THE NATIONAL ACADEMIES

Level of Service Definitions

Signal Controlled Intersections

- The level of service and capacity are signalized intersection measurements.
- Levels of service range - LOS A (relatively congestion-free) and LOS F (congested).
- The capacity of a signalized intersection is based upon the maximum flow and the traffic volume demand.
- V/C ratio of 1.0 indicates traffic volume demand equals the maximum flow.

Level of Service Definitions

Signal Controlled Intersections

The level of service of a signalized intersection is evaluated on the basis of average control delay per vehicle on all approaches:

- Level of service A describes very low delay. Most vehicles do not stop.
- Level of service B more vehicles stopping causing higher average delays.
- Level of service C has higher delays. Many vehicles still pass through the intersection without stopping.
- Level of service D means many vehicles are influenced by congestion.
- Level of service E is considered the limit of acceptable delay. Individual cycle failures are frequent occurrences.
- Level of Service F has delays unacceptable to most drivers. This condition often occurs with over saturations.

Level of Service Definitions

Stop Controlled Intersections

The level of service and capacity of a two-way stop controlled intersection are used to measure the quality of the traffic operations.

Levels of service range - LOS A (relatively congestion-free) and LOS F (very congested).

The capacity of a controlled minor approach is based on the distribution of gaps in the major street traffic flow.

The level of service for a minor approach of a TWSC intersection is evaluated based on the average total delay per vehicle.

Level of Service Definitions

Signalized Intersections

LOS	DELAY PER VEH. (SEC)
A	≤ 10.0
B	> 10.0 and ≤ 20.0
C	> 20.0 and ≤ 35.0
D	> 35.0 and ≤ 55.0
E	> 55.0 and ≤ 80.0
F	> 80.0

Unsignalized Intersections

LOS	DELAY PER VEH. (SEC)
A	≤ 10.0
B	> 10.0 and ≤ 15.0
C	> 15.0 and ≤ 25.0
D	> 25.0 and ≤ 35.0
E	> 35.0 and ≤ 50.0
F	> 50.0

Manual on Uniform Traffic Control Devices

for Streets and Highways

2009 Edition

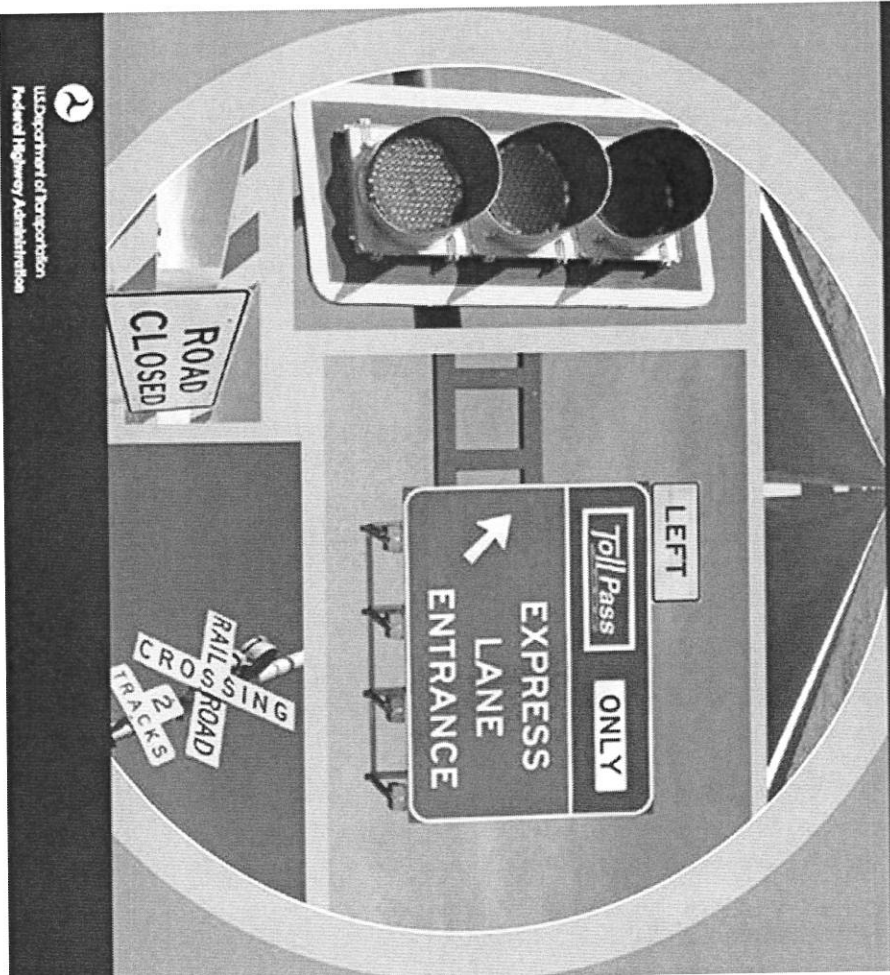

 U.S. Department of Transportation
Federal Highway Administration

2009 Edition Chapter 4C. Traffic Control Signal Needs Studies

Engineering study - performed to determine whether traffic control signal is justified.

The investigation of the need shall include - analysis of existing operation and safety, potential to improve these conditions, & the following traffic signal warrants:

- Warrant 1, Eight-Hour Vehicular Volume
- Warrant 2, Four-Hour Vehicular Volume
- Warrant 3, Peak Hour
- Warrant 4, Pedestrian Volume
- Warrant 5, School Crossing
- Warrant 6, Coordinated Signal System
- Warrant 7, Crash Experience
- Warrant 8, Roadway Network
- Warrant 9, Intersection Near a Grade Crossing

2009 Edition Chapter 4C. Traffic Control Signal Needs Studies

The satisfaction of a traffic signal warrant or warrants shall not in itself require installation of a traffic control signal.

Guidance:

- Engineering judgment should be applied.
- Conflict of minor-street right-turn traffic with traffic on the major street should be considered.
- Right-turn traffic should not be included in the minor-street volume if the movement enters the major street with minimal conflict.

2009 Edition Chapter 4C. Traffic Control Signal Needs Studies

Most DOTs including NHDOT typically require satisfying Warrant 1 Eight-Hour Vehicle Volume.

Table 4C-1. Warrant 1, Eight-Hour Vehicular Volume

		Condition A—Minimum Vehicular Volume							
		Vehicles per hour on major street (total of both approaches)			Vehicles per hour on higher-volume minor-street approach (one direction only)				
Major Street	Minor Street	100% ^a	80% ^b	70% ^c	56% ^d	100% ^a	80% ^b	70% ^c	56% ^d
1	1	500	400	350	280	150	120	105	84
2 or more	1	600	480	420	336	150	120	105	84
2 or more	2 or more	600	480	420	336	200	160	140	112
1	2 or more	500	400	350	280	200	160	140	112

		Condition B—Interruption of Continuous Traffic							
		Vehicles per hour on major street (total of both approaches)			Vehicles per hour on higher-volume minor-street approach (one direction only)				
Major Street	Minor Street	100% ^a	80% ^b	70% ^c	56% ^d	100% ^a	80% ^b	70% ^c	56% ^d
1	1	750	600	525	420	75	60	53	42
2 or more	1	900	720	630	504	75	60	53	42
2 or more	2 or more	900	720	630	504	100	80	70	56
1	2 or more	750	600	525	420	100	80	70	56

^a Basic minimum hourly volume

^b Used for combination of Conditions A and B after adequate trial of other remedial measures

^c May be used when the major-street speed exceeds 40 mph or in an isolated community with a population of less than 10,000

^d May be used for combination of Conditions A and B after adequate trial of other remedial measures when the major-street speed exceeds 40 mph or in an isolated community with a population of less than 10,000

Engineering Judgement (Considerations)

- What movement experiences the LOS F Delay?
- How many vehicles experience the LOS F Delay?
- What is crash history?
- Would typical crash be avoided by traffic signal?
- Would traffic signal result in increased crashes?
- Would traffic be diverted to new traffic signal?
- Would lanes need to be added with the traffic signal?
- Would speed limits need to be reviewed?

Questions

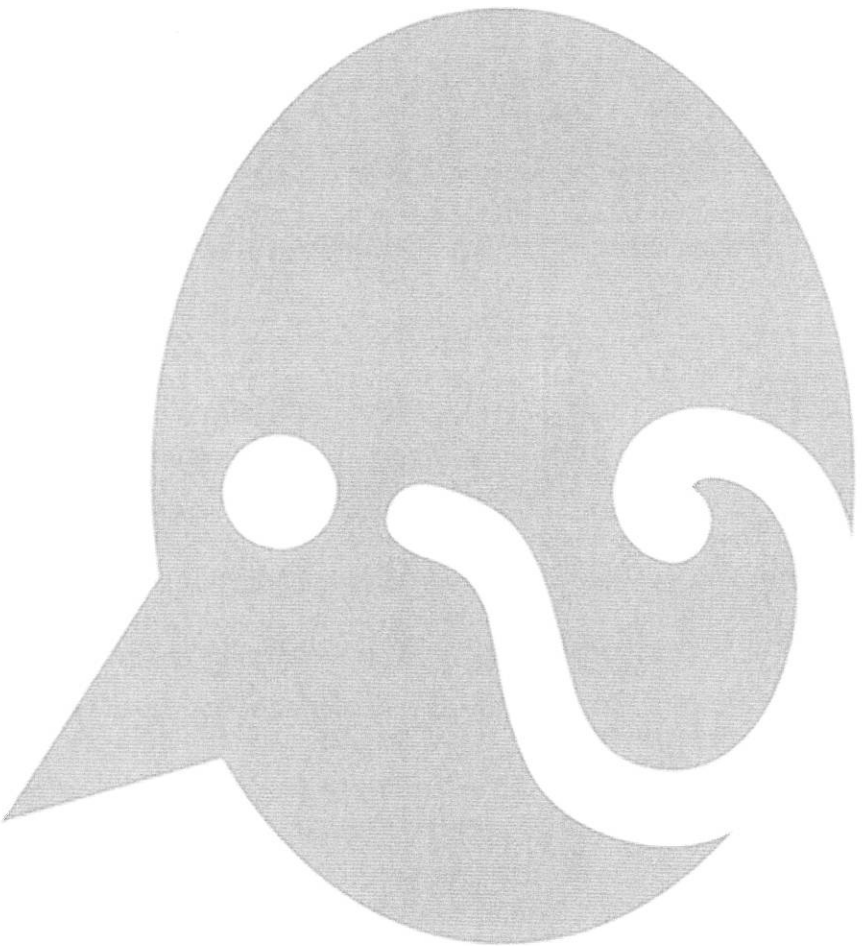

Parlinet Presentation

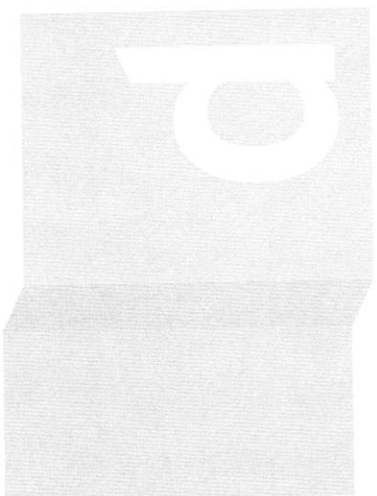

parlinet

Town Council

Londonberry, NH

July 10, 2017

Ian Hill, Founder

ian@parlinet.com

603.998.7605

Who we are

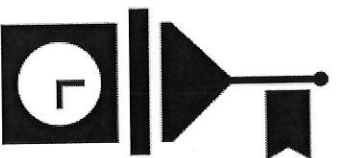

We're helping citizens **understand** and **participate** in their local government.

The Parlinet Platform

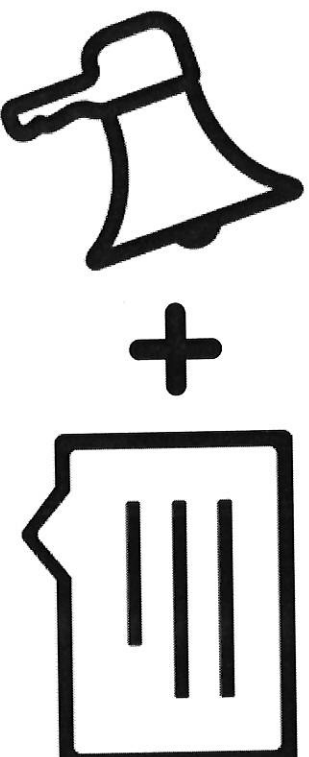

An improved online **notification** and **public comment** tool for local and state government.

Why am I here?

We want to provide Parlinet for **free** to Londonderry.

Why?

- To receive feedback
- To prove Parlinet can measurably improve civic engagement



Londonderry today...

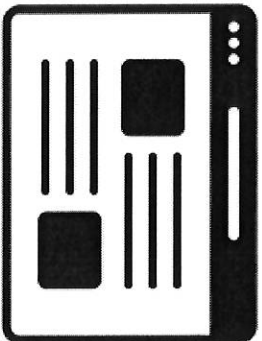

Website

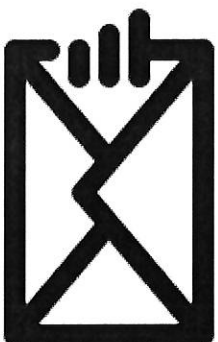

E-Alerts
(email lists)

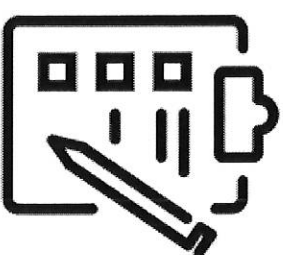

Comment
Form



Dick stores
GMA 4ND
Contribution
5
Night of Columbus

Londonderry today...

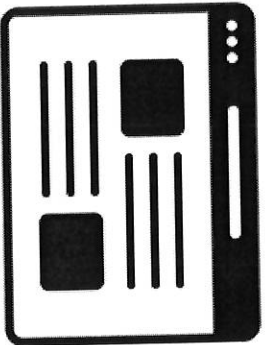

Website

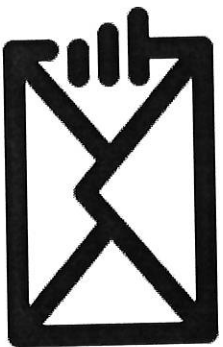

E-Alerts
(email lists)

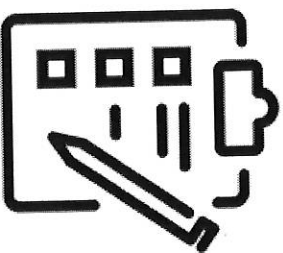

Comment
Form

Londonderry today...

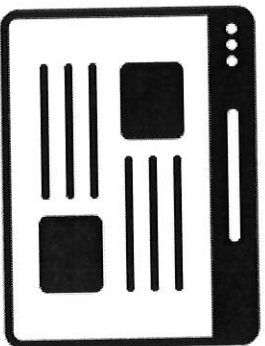

Website



Today's E-Alerts



- E-Alerts
- Built for the politically savvy
 - Organized by committee or dept.
 - Citizens already have to know what they're looking for

Parlinet Notifications

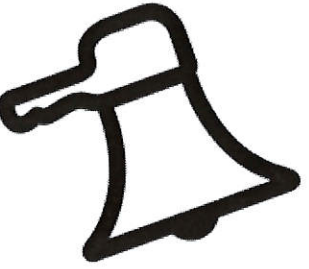

- Notifications
- Issue oriented and searchable
 - Easy and automatic
 - Engage citizens earlier in the legislative process

Today's Feedback Forms

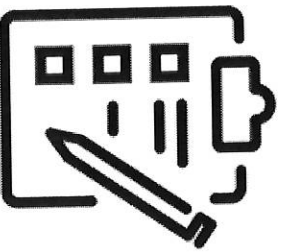

Forms

- Burden falls on staff and officials
- Repeat questions take time to answer
- Not social (missed opportunity)

Parlinet's Questions and Suggestions

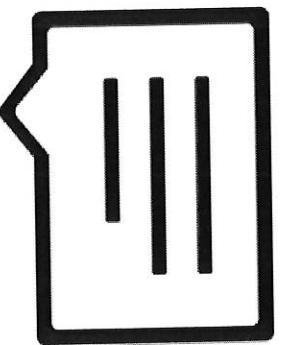

Questions & Suggestions

- Visible to the whole community (effectively creating a FAQ page)
- Avoid duplicate questions
- Leverage citizen expertise
- Eliminate misinformation
- Open Meeting Law protections

Why Parlinet?



Save Time
for Staff and
Officials



Collaborate
with
Citizens

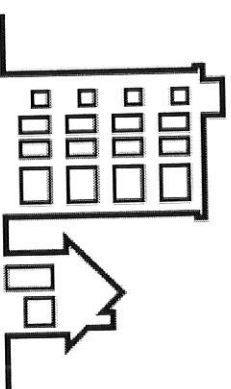

Promote
Civic
Discussion

Long Term Benefits



Londonderry, NH

Long Term Benefits



Town

Long Term Benefits

County



Town



Long Term Benefits

State



County



Town



Parlinet for Londonderry

The Details

- **6 months FREE** for Londonderry
- **Launch in ~1 month**

Why?

- We're looking for feedback
- We want to point to Londonderry as a model Parlinet community



Next Steps

- **Today:** Town Council Approval
- **July 31:** Prepare marketing with Town Manager, Library Staff
- **Aug. 7:** Launch to Londonderry
- **Sept. 4 - Feb. 5:** Update the Town Council and request feedback
- **Feb. 5:** Consider paid subscription

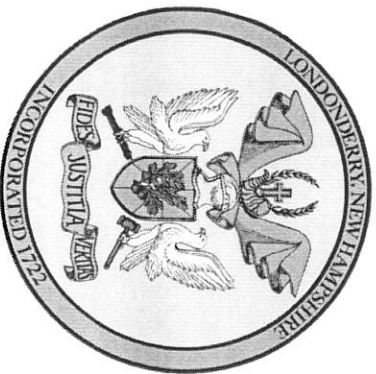

Dendrochronology Study

c.1722, 24 Griffin Rd



Dendrochronology Study Proposal

The dendrochronology study of the building will consist of a site visit by William Flynt to obtain samples followed by sample preparation (mounting, sanding, species confirmation, ring counts), microscopic measuring, data analysis, and a written report, all conducted in Deerfield.

In undertaking a dendrochronology study of any timber frame structure, a number of parameters need to be met in order for the study to have a decent chance of success. It should be noted, however, that even if all the criteria are met, there is always a possibility that the results will be inconclusive.

The following parameters must be taken into consideration;

1. Ideally, 10-15 samples need to be obtained from each distinct period of construction that is being investigated. This is not always possible due to lack of suitable samples.
2. Timber species must be Oak, Pitch pine, Hemlock, Spruce, or possibly Chestnut and White pine as these species are the only ones for which there currently exist regional dated master chronologies/ site chronologies.
3. Waney, or bark edge, timbers of sufficient numbers must be accessible for coring.
4. Timbers must have a minimum of 55-60 growth rings to be useful.
5. Coring leaves 9/16" holes. The holes are plugged if so desired.
6. While not mandatory, it is best if the study has access to any current research pertaining to the structure/site. Floor/framing plans are also recommended and need to be made available for the study, if they exist, for plotting sample locations.

Fees

The cost of the complete study is based on obtaining 10-15 samples per building phase of interest, with a minimum fee set at \$750, should less than 8 samples be taken. In addition travel reimbursement will be figured in as a separate item based on .50/mile. If no suitable samples can be obtained, costs will be limited to a prorated daily rate of \$350, plus mileage.

10-15 samples per building phase @ \$100/sample-----	\$1000-1500
Mileage	Varies depending on location

Bill Flynt
Architectural Conservator
Historic Deerfield, Inc.
413-775-7210
wflynt@historic-deerfield.org

**REPORT ON THE HOLMES HOUSE
24 GRIFFIN ROAD
LONDONDERRY, NEW HAMPSHIRE
APRIL 30, 2017**

ARCHITECTURAL HISTORY HISTORIC PRESERVATION

JAMES L. GARVIN
FARRINGTON HOUSE

30 South Main Street · Building 1, Suite 201 · Concord, New Hampshire, 03301
james@jamesgarvin.net jlgarvin@mail.plymouth.edu <http://www.james-garvin.com>



Holmes House, North and East (Front) Elevations

Acknowledgments

Several members of the Londonderry Historical Society have been instrumental in providing safe access to the Holmes House for the purpose of gathering data for this report.

I am especially thankful:

to David Colglazier, who initially contacted me about the building and sent numerous photographs of the interior before the house was readied for inspection, as well as sharing many photographs that he took during the inspection on April 28, 2017;

to Ann Chiampa, who with others invested uncounted hours making the house safe for inspection under unpleasant circumstances, bagging the debris that filled the house, stacking the abandoned furniture and household goods that encumbered each room, and creating pathways through the building to permit inspection and analysis of the features described in this report,

to John Savina, president of the Londonderry Historical Society, who patiently accompanied the inspection on April 28th, having previously contributed many hours in cleaning the house and making it safe, and

to Sue Joudrey, secretary of the Society, who likewise donated countless hours in trying to make the abandoned house safe and accessible for inspection.

The following report would not have been possible without the hard work and dedication to Londonderry's history of these people and others who assisted in the effort of making an inspection possible.

Summary: This report is based on brief inspections of the Holmes House on April 23 and 28, 2017. The purpose of the inspections was to determine the origins and evolution of the dwelling, and to identify the building's character-defining features. This report was prepared at the request of the Londonderry Historical Society in an effort to understand the significance of the house, which may be demolished after April 30, 2017.

As described below, the Holmes House appears to be an eighteenth-century dwelling that was stripped of its original interior partitions and finish materials and thoroughly remodeled circa 1850, and then had most of its circa 1850 interior finish removed in a second major remodeling in the late twentieth century. The twentieth-century remodeling exposed the framing system of the second story of the house, seen below and shown in the drawing on the following page.

This exposure disclosed the fact that the framing system is unusual in incorporating a series of four internal bridging joists, often called "summer beams," and two gable-end girts that extend across the house from front to rear and are tenoned into structural posts within the walls. More unusual for an eighteenth-century dwelling, these posts extend above the floor of the second story, where they are capped by front and rear wall plates that support the roof system of the building. This framing configuration creates a knee-wall dwelling.

Knee-wall houses are generally unknown in New Hampshire until 1830 or later. The remarkable appearance of an eighteenth-century knee-wall house frame in Londonderry raises the question of whether this house represents a localized vernacular framing tradition. The original settlers of Londonderry and its neighboring towns were Scottish Presbyterians who emigrated from Ulster County in Ireland, where British authorities had settled their ancestors in the seventeenth century. Arriving in New Hampshire a full century after the original English settlers, these immigrants may be supposed to have brought with them carpentry traditions and vernacular building forms that differed noticeably from those of earlier-settled regions of the province. It is possible that the Holmes House reflects such traditions. It is therefore important to glean all possible insight into the nature of this house before it disappears, thus potentially providing points of comparison with other unrecognized early houses in the Londonderry region.

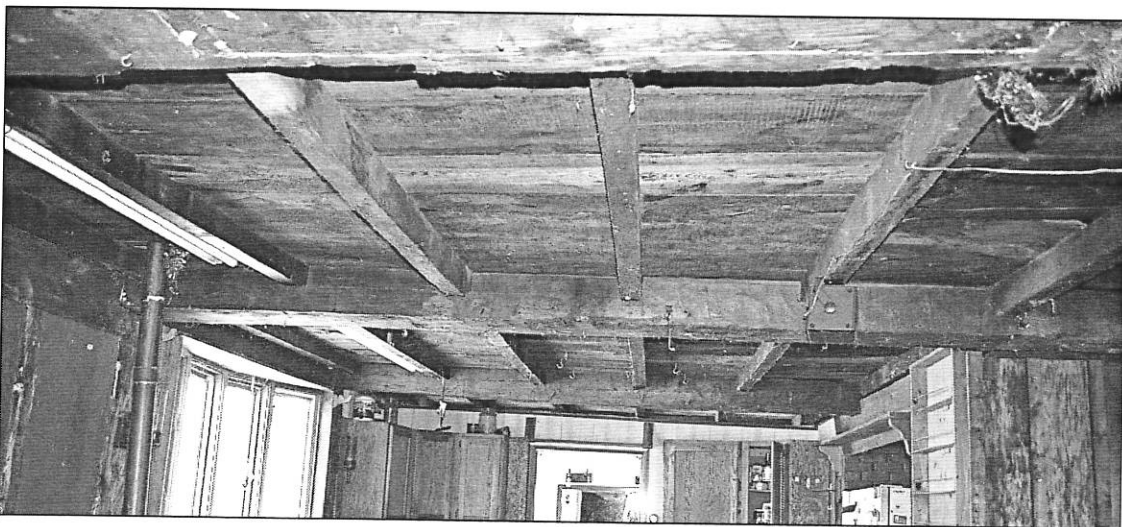

Above: Rear area of Holmes House, looking north, showing bridging joists and common joists.

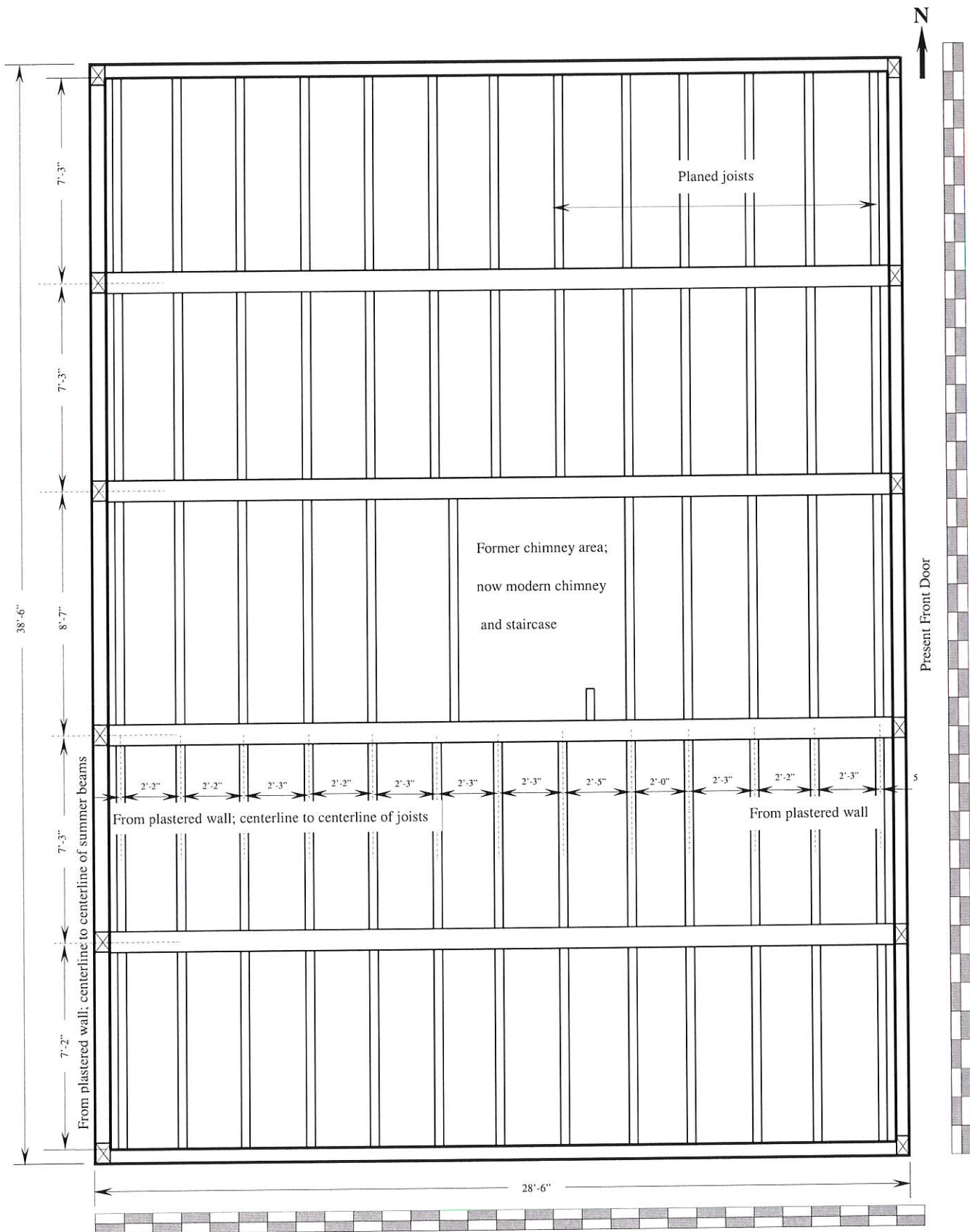

FRAMING PLAN OF THE SECOND STORY OF THE HOLMES HOUSE

Londonderry Settlement: The territory of Londonderry originally incorporated not only the present-day town of Londonderry, but also Derry, Windham, and parts of the towns of Hudson and Litchfield and of the city of Manchester. Londonderry's settlers were mostly from a group of sixteen families, part of a larger cohort who arrived in New England in 1718, chiefly from three parishes in northern Ireland, and petitioned the Province of Massachusetts-Bay for a grant of land. In 1719, the Province of New Hampshire granted the petitioners a tract of some 64,000 acres, which they originally named Nutfield, apparently for the prevalence of chestnut trees in the forests.¹ Londonderry was chartered in 1722 as the southernmost in a line of new townships created under the authority of the Province of New Hampshire beyond the western boundaries of the original towns of Hampton, Exeter, and Dover.²

The cultural world of the Scots-Irish settlers of New Hampshire is best understood through one primary source and one secondary source. The primary source is the extensive and detailed diary of Matthew Patten (1719-1795) of Bedford, N. H., who was born in Ireland. Patten moved to the Province of New Hampshire in 1728 at the age of nine. He was appointed justice of the peace in 1751 and held that post until his death. In 1776 and 1777 he represented Bedford and Merrimack in the general court. The diary he kept from 1744 to 1788 has been an important source for historians of New Hampshire, and particularly for understanding Scots-Irish life and culture. The diary was first published in 1903 and was reprinted with an index in 1993.³

The secondary source of information on Scots-Irish culture is a Ph.D. dissertation by a contemporary New Hampshire historian, R. Stuart Wallace.⁴

The physical world that these early settlers created has been little studied. Much of what has been written has focused on the specialized agricultural practices of this ethnic group, particularly on their introduction of the potato into New England and their unusual skill in the spinning of flax and the weaving of fine linen cloth. Most research on the material culture of the Scots-Irish in New Hampshire has focused on aspects of the design and ornamentation of their artifacts.⁵ There has been little or no research on the form or construction of their houses or

¹ *Provincial Papers of New Hampshire*, 24:171 and 25:272-8.

² For early and recent accounts of the Londonderry settlement, see Edward Lutwyche Parker, *A Century Sermon, Delivered in the East-Parish Meeting House, Londonderry, New Hampshire, April 22, 1819 in Commemoration of the First Settlement of the Town* (Concord, N. H.: George Hough, 1819); Parker, *The History of Londonderry, Comprising the Towns of Derry and Londonderry, N. H.* Edward P. Parker, ed. (Boston: Perkins and Whipple, 1851); R. Stuart Wallace, "The Scotch-Irish of Provincial New Hampshire," Ph.D. dissertation, University of New Hampshire, 1984.

³ *The Diary Of Matthew Patten Of Bedford, N. H. 1754-1788* (Concord, N. H.: Rumford Printing Co., 1903; Camden, Me.: reprinted for the Bedford N. H. Historical Society by Picton Press, 1993).

⁴ R. Stuart Wallace, "The Scotch-Irish of Provincial New Hampshire," Ph.D. dissertation, University of New Hampshire, 1984.

⁵ See, for example, Martha Coons, *All Sorts of Good and Sufficient Cloth: Linen-Making in New England, 1640-1860* (North Andover, Mass.: Merrimack Valley Textile Museum, c. 1980); Peter Benes, "John Wight: The Hieroglyph Carver of Londonderry," *Old-Time New England* 64 (1973-4): 30-41; David H. Watters "'Fencing ye Tables': Scotch-Irish Ethnicity and the Gravestones of John Wight," *Markers XVI* (1999), pp. 174-209 (an earlier version of this article appeared in *Historical New Hampshire* 52 (1997): 2-17 (gravestone studies); and Charles S. Parsons, *The Dunlaps and Their Furniture* (Manchester, N. H.: The Currier Gallery of Art, 1970); Philip Zea and Daniel Dunlap, *The Dunlap Cabinetmakers: A Tradition in Craftsmanship* (Mechanicsburg, Pa.: Stackpole Books, 1994) (furniture studies).

other buildings. The absence of such analysis or comparative data makes the study of the Holmes House especially urgent, given the likely demolition of the building in the near future.

One former Londonderry house may offer a context, however partial, for the Holmes House. This is the “Seaborn Mary” House, a Londonderry dwelling that is believed to date from c. 1730 and was disassembled and re-erected in Little Compton, Rhode Island, in 1937. The house is reputed to have been the original home of Mary Wilson Wallace (1720-1814), an early Londonderry settler.⁶ Under the modern name of “Ocean-Born Mary” or “Seaborn Mary,” Wallace has become well-known in New Hampshire, partly through the fictionalized writing of author Lois Lenski and through the opening of her later home in Henniker, New Hampshire, built by her son in the 1790s, to tourists in the first half of the twentieth century.⁷

As seen below, the Seaborn Mary House differs from the Holmes house in several respects. It is a one-room-deep dwelling with a gambrel roof instead of a gable roof. Its wall plates, which define the eaves of the roof, lie just above the windows rather than being elevated by a knee wall, as in the Holmes House.

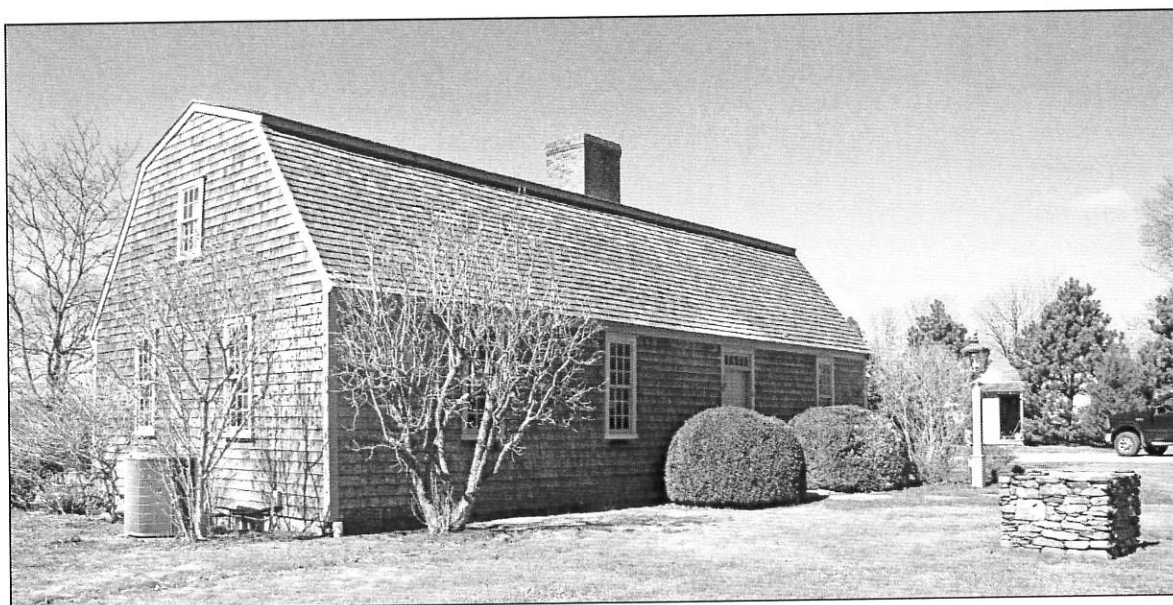

“Seaborn Mary” House, c. 1730, South of Commons Road, Little Compton, Rhode Island, moved from Londonderry, New Hampshire, to Rhode Island in 1937.

As far as can be determined, there are no readily available drawings that detail the framing characteristics of the Seaborn Mary House. Despite its clear differences from the Holmes House,

⁶ Rhode Island Historical Preservation Commission, *Historic and Architectural Resources of Little Compton, Rhode Island* (Providence: Rhode Island Historical Preservation Commission, 1990), p. 67.

⁷ Lois Lenski, *Ocean-Born Mary* (New York: J. B. Lippincott, 1939); Marion Sargent Connor, “Memories and Legends of Ocean-Born Mary,” *New Hampshire Profiles*, May 1954, pp. 22-4; Andrew E. Rothovius, “Ocean Born Mary, the Ghost Who Never Was,” *New Hampshire Profiles*, November 1968, pp. 32-6; Jeremy D’Entremont, *Ocean-Born Mary: The Truth Behind a New Hampshire Legend* (The History Press, 2011).

however, the Seaborn Mary House shares one principal characteristic with the Holmes House. As seen in the photograph below, the house utilizes a second-floor (attic floor) framing system that is highly similar to that of the Holmes House. Both houses utilize a series of hewn summer beams or bridging joists that extend laterally through the building, linking front and rear wall posts and providing support for ranges of sawn common joists that hold the floor boards above.

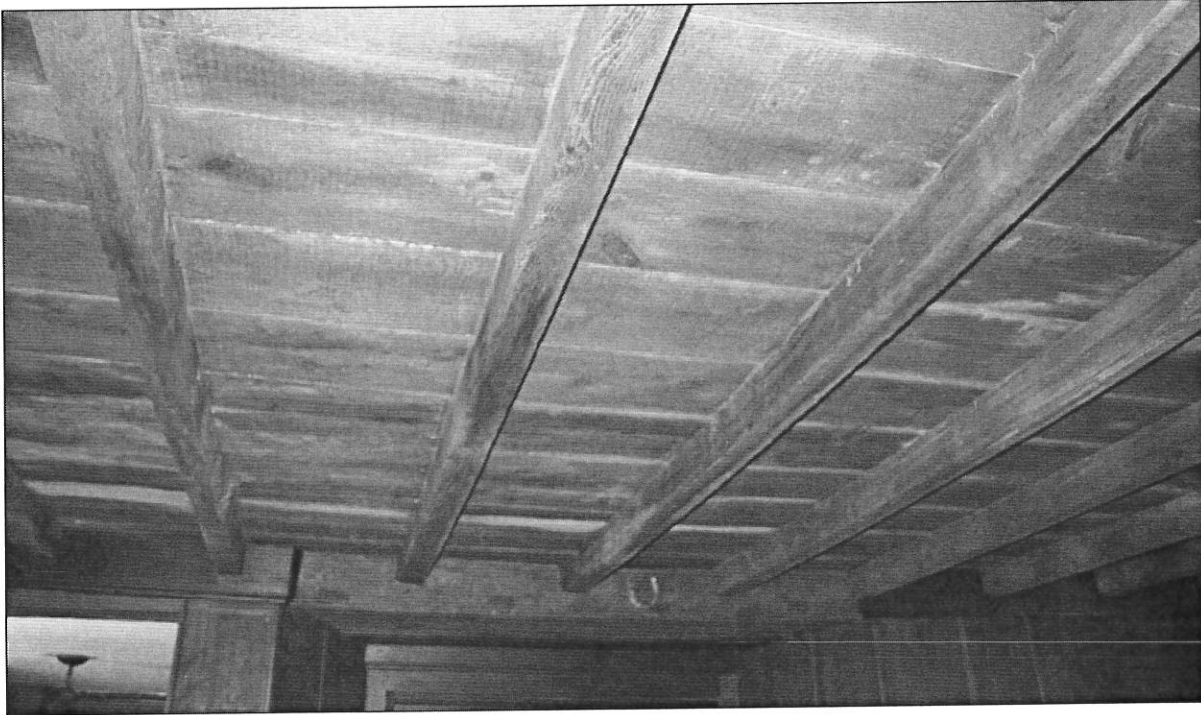

Parlor ceiling, looking north, "Seaborn Mary" House, c. 1730, Little Compton, Rhode Island.

Summary of the Evolution of the Holmes House: As shown above, the frame of the Holmes House shares structural characteristics with the Seaborn Mary House and appears to be an eighteenth-century structure. Further examination of evidence may confirm this general date, but a more accurate date for the house and a fuller history of ownership may eventually be revealed through deed research and other documentary investigation. As noted below, the frame of the Holmes House is the element of the building that holds the highest research value; the interior finishes of the building almost all date from the mid-1800s or the late twentieth century.

Very little evidence of the original room layout of the Holmes House is visible today. Because of its 28-foot depth, the house may be supposed to have been subdivided originally by partitions that created front rooms and rear rooms. The house differs from a standard "English" house, however, and there are no detectable structural posts in the gable walls that would define the dividing line between front and rear rooms in such a house, as shown in the plan below.

Typically, an "English" house has four frames that compose its skeleton: two in the end or gable walls, and two that embrace the chimney in the center of the building. Each frame has three

posts, one at the front wall of the building, one at the rear wall, and one just behind the chimney, as shown below.

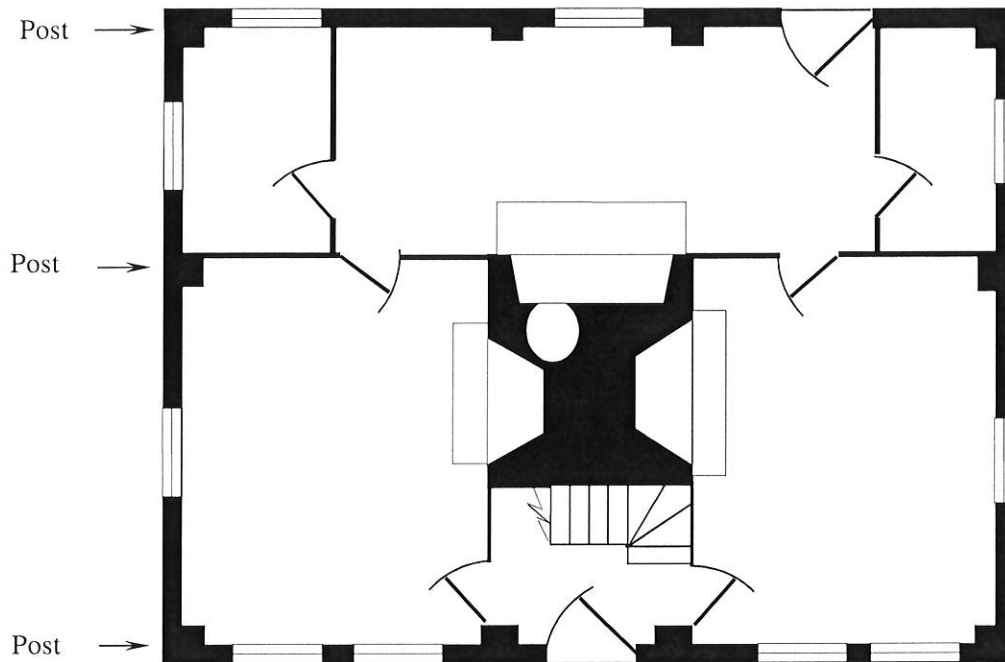

Floor plan of a typical "English" house, showing the three posts that compose parts of the framing units and define the division between front and rear rooms in the dwelling.

By contrast, as seen in the framing plan on page 2, there are no middle posts in any of the six framing units that compose the end walls and interior frame of the Holmes House. The absence of such posts makes it difficult to guess at the original floor plan or room layout of the house.

Changes that were carried out to the Holmes House in the nineteenth century further compounded the difficulty of interpreting the original interior character of the building. Stylistic and structural evidence shows that the house underwent a thorough remodeling around 1850, with a possible earlier remodeling shortly after 1800. Pending deed or probate research that may clarify the ownership of the property over time, the c. 1850 remodeling may be attributed to ownership of the house by Charles M. Holmes (1820-1897) and his wife, Mary Batchelder Holmes, whom he married in 1847. The 1850 United States Census shows that the household of Charles and Mary Holmes included a one-year-old daughter, Mary, and Elizabeth Anderson Holmes, Charles' mother, aged 67. By 1860, Charles and Mary Holmes had a son, Christopher, real estate valued at \$3,000, and personal estate valued at \$600. Elizabeth Anderson Holmes was still living with the family. By 1870, the value of the Holmes real estate had increased to \$5,000, and of the personal estate to \$2,000, making the family relatively wealthy.

Physical evidence shows that the Holmes House was transformed during the mid-1800s. Whatever its original appearance may have been, the house was remodeled into an example of the then-fashionable Greek Revival farmhouse. To accomplish this, the original roof frame of

the house was separated at the ridge, the upper ends of the rafters were lifted and held apart by plank cleats nailed to their sides, and new materials were added to extend the ridge to its present elevation.

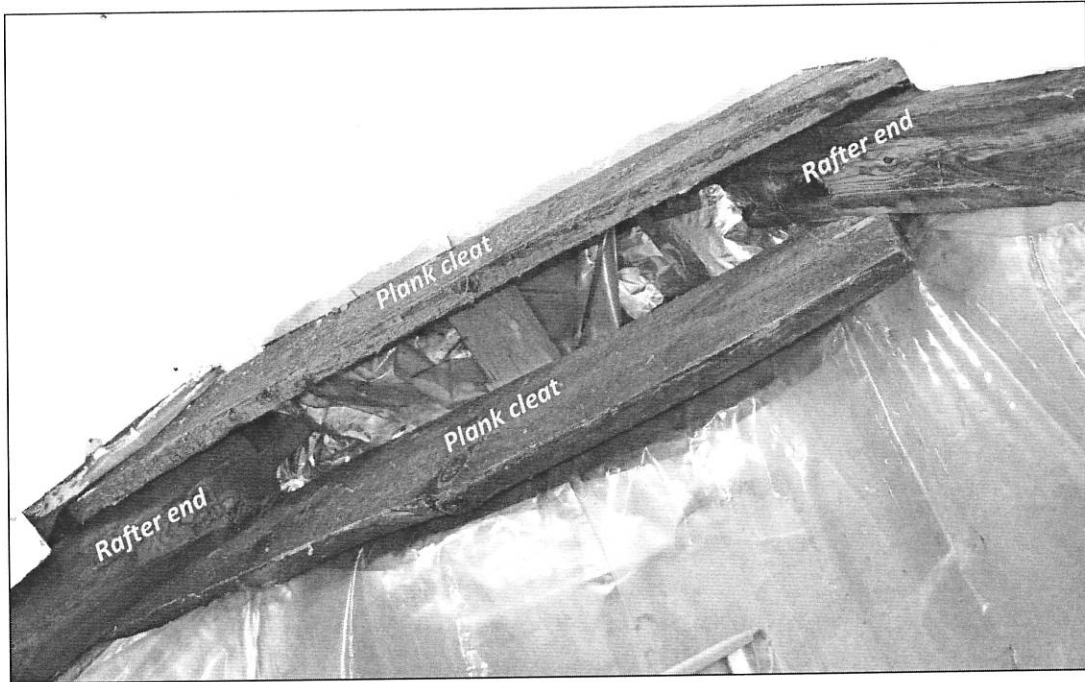

Attic rafters, showing separation at the original ridge and insertion of plank cleats to hold the rafters in lifted position. Additional framing was added above to support the raised ridge.

With the geometry of the house altered, stylistic details were added on the exterior and interior. The most characteristic exterior feature was a new front doorway in the robust but fashionable Greek Revival style. The original window placement of the house is unclear, but the house was given a balanced façade with two windows on each side of the front doorway if it did not already have such symmetry. The window sashes were updated to display a muntin profile that was fashionable at the time.

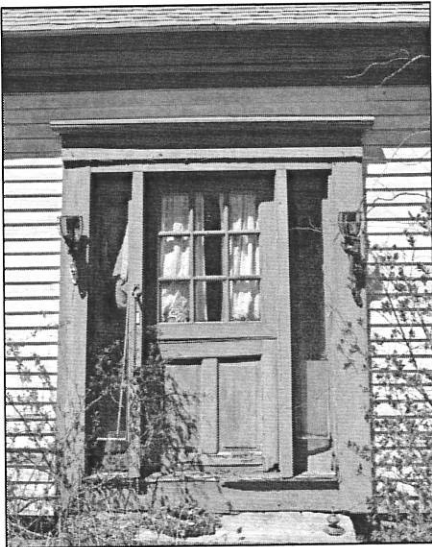

Left: Front doorway, circa 1850.

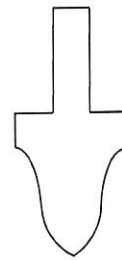

Right: Window muntin profile, circa 1850.

Although almost all of the interior detailing that was added throughout the house circa 1850 was removed when the interior was again remodeled in the late twentieth century, there remain clues

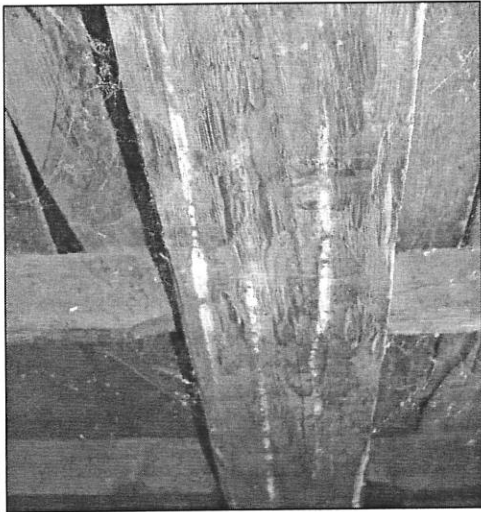

regarding its character. As seen at the left, lime stains on the bottoms of the heavy beams of the second floor frame show that the first story was provided with plastered ceilings. There is relatively little evidence of ceiling plaster prior to this date, so it appears that the ancient character of the interior was retained until the transformation of the mid-1800s. The new ceilings were dropped to the elevation of the bottoms of the heavy beam, undoubtedly by the common practice of nailing boards to the sides of the smaller joists and nailing the new lath to the bottom edges of these boards.

Left: Lime stains from former ceiling lath and plaster on the bottom of a bridging joist or summer beam, northeast room.

Remnants of the character of the interior work of circa 1850 are seen in the front entry of the house and the two partitions that extend from this entry toward the rear of the dwelling. The entry is fully plastered, as was the entire first story. The room to the north of the entry retains its mid-nineteenth-century door casings. These display a symmetrical profile and corner bosses that became fashionable around 1830 and remained so until about 1900.

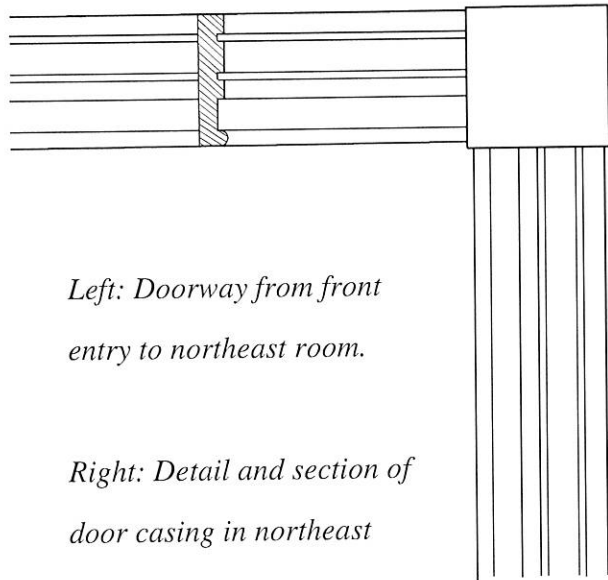

Left: Doorway from front entry to northeast room.

Right: Detail and section of door casing in northeast room.

A strong indication of the ambitious nature of the mid-century remodeling is offered by the basement walls of the house. It is impossible to tell whether the original dwelling had a full cellar, but it is likely that it did not. Excavation of full basements was rather uncommon in eighteenth-century houses due to the difficulty of digging in the rock-laden and sometimes ledgy New Hampshire soil. Cellars were used primarily for storage of root crops and other food supplies, and when used for that purpose did not necessarily need to be as large as the full footprint of the house.

The fashion for full basements increased during the nineteenth century. In the case of the Holmes House, physical evidence shows that the entire house was lifted and supported, a full basement was excavated if it did not exist, and new cellar walls of split granite boulders was constructed up to the elevation of the exterior grade. Above grade, the house was underpinned with slabs of granite backed by a veneer of brickwork.



This granite foundation may be dated at 1830 or later through evidence of the splitting technique that was employed on the cellar walls and underpinning slabs, as explained in the Appendix to this report.

Left: North wall of the basement, showing the walls of split fieldstones and the brick backing for the granite underpinning that is visible above grade on the exterior of the house.

Description of the Holmes House as Originally Built: As described above, little remains to characterize the Holmes House as it was originally built except for the frame. Elements of the frame have been altered, especially in the course of raising the pitch of the roof, yet the frame of the body of the house appears to remain largely intact. The following is a description of the frame as it stands and insofar as it can be described given the fact that most walls and the roof frame are covered by materials from the mid-1800s and from the late twentieth century.

The frame measures 28'6" in depth (front to back) and 38'-6" in length. It is composed of front and rear broadsides, each having sills, corner posts, and four intermediate posts, capped by a wall plate that appears to be continuous along the length of the house. The knee-wall design of the frame suggests that the front and rear walls were probably raised as preassembled units that were linked together across the depth of the building by the insertion of the bridging joists or summer beams. As shown in the drawing on the following page, the total height of the frame from the top of the sills (first floor elevation) to the top of the front and rear wall plates is about 10'-0." The height of the individual wall posts (cited in eighteenth-century terminology as the distance "between joints") is about 9'-4.

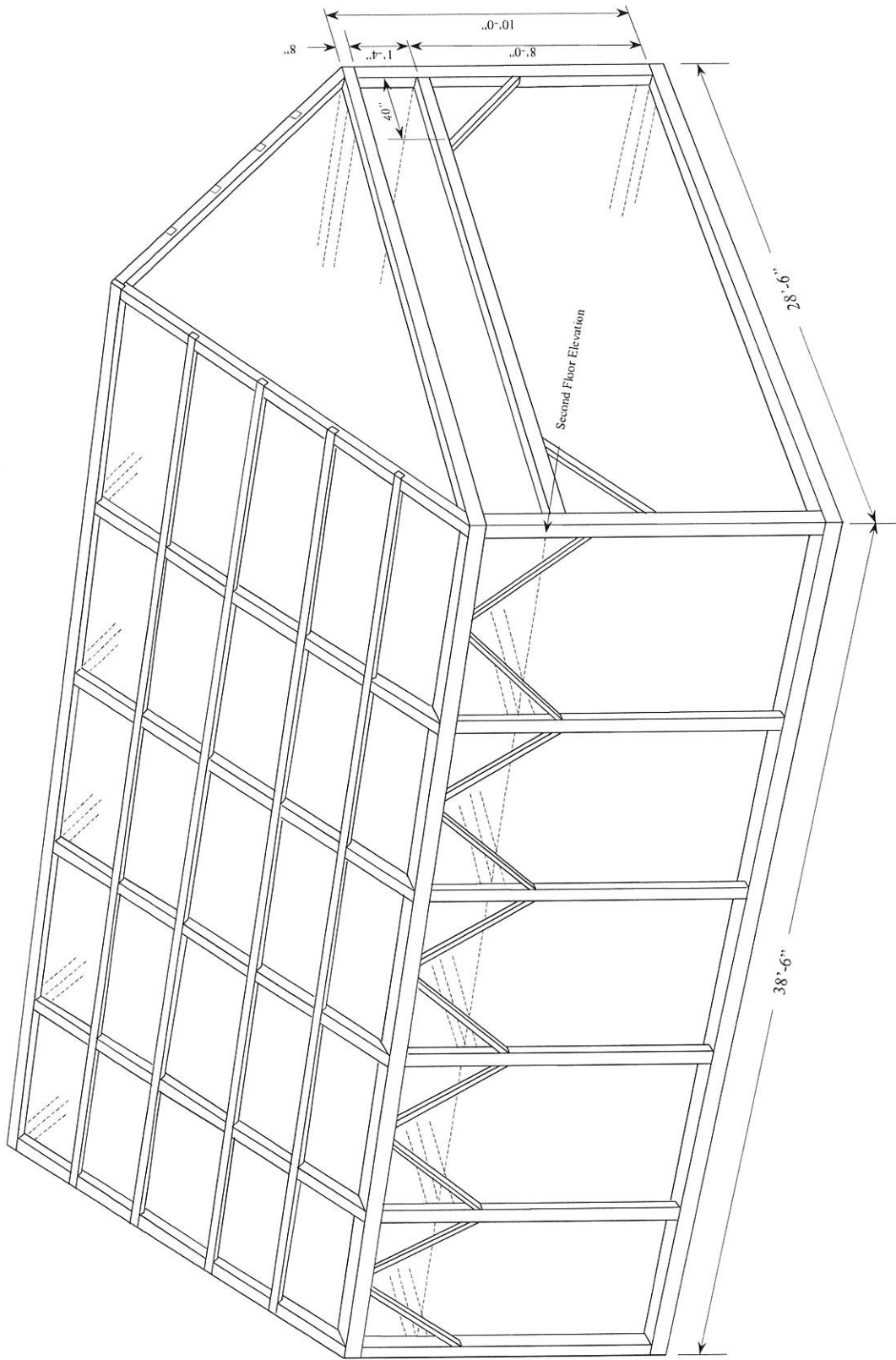

HOLMES HOUSE FRAME—AXONOMETRIC VIEW

Not to Scale

All elements of the frame, except for the common joists in both the first and second floor frames, are hewn. The wall posts are oak, apparently white oak (*Quercus alba*). The corner posts are heavier than the intermediate front and rear wall posts; they measure approximately 7¼" square, while the intermediate posts are 8" broad but only 4½" deep. This depth is about the same as that of the wall braces, and in one instance in the rear (west) wall near the center of the house, the mortise for a brace is actually exposed to view where lath and plaster have been removed, and the end of the brace is visible in its pocket. At present and perhaps always, the lath and plaster of the walls is nailed to the inner faces of the thin intermediate posts, creating flush wall surfaces that are not interrupted by projecting posts. On the other hand, as noted below, the tops of the posts are somewhat thicker above the second floor, suggesting that the posts could have been hewn back to thinner dimensions on the first story to allow lath and plaster to hide their presence in the walls.

In some cases, the corner posts have been hewn back on the first story to remove their projections in the corner of the room. This is particularly noticeable in the northwest first story room, a space that seems to have been treated with special attention from the beginning. Here, the corner post has been diminished up to the ceiling of the room; above the ceiling, as seen in the knee-wall on the second story, the post retains its original dimensions.

As noted previously, there is slight evidence of a remodeling of the house in the early 1800s, almost completely erased by the extensive remodeling of c. 1850. The house retains two four-panel doors with raised panels and elaborated stile and rail moldings, one of which is seen in the photograph on page 8. These doors are typical of the early Federal style. Many of the hewn framing members of the house were expertly hewn with a broad-axe, a technique that leaves a somewhat rough and uneven surface when not followed by smoothing with an adze. Such a surface is seen in the photograph of a bridging joist (summer beam) on page 8.

Such hewn surfaces were normally covered by planed one-inch board casings. No such casings survive now on most framing members, having probably been removed when dropped lath-and-plaster ceilings were installed in the house during the remodeling of c. 1850. The corner post at the southeast corner of the first story, however, retains such a casing, largely hidden behind the side of a built-in bookcase. This suggests the likelihood that all the heavy members of the frame—the bridging joists or summer beams and the four corner posts, were covered by casings, either originally or at some later date.

The bridging joists (summer beams) are hewn from a conifer, apparently eastern white pine (*Pinus strobus*). Their dimensions vary somewhat, but average 8 inches in height and 10 inches in breadth. They are remarkable in spanning the full 28-foot depth of the house without internal support, at least as seen today. These members are considerably longer in unsupported span than other summer beams ordinarily found in "English" houses, where such beams ordinarily run some fifteen feet across the width of a room. Where such beams are utilized as tie beams in a roof frame, as they often are, they may run from front to back of the building but usually benefit from some support from a partition or longitudinal medial plate that divides front rooms from rear rooms at intermediate wall posts, as shown in the plan on page 6.

The common joists of the second floor frame were sawn in a reciprocating or “upright” sawmill. Where their grain is visible (many are painted), these joists are seen to be oak, apparently white oak (*Quercus alba*). Their dimensions vary somewhat, but they average 3 inches in width and 4 to 4¾ inches in height. Except in the presumed location of the former chimney, their spacing is quite uniform throughout the house, as shown on the second floor framing plan on page 2. As seen in the photograph on page 8, and below, the common joists are diminished slightly at their ends, forming simple cogs that rest in notches in the bridging joists that support them.

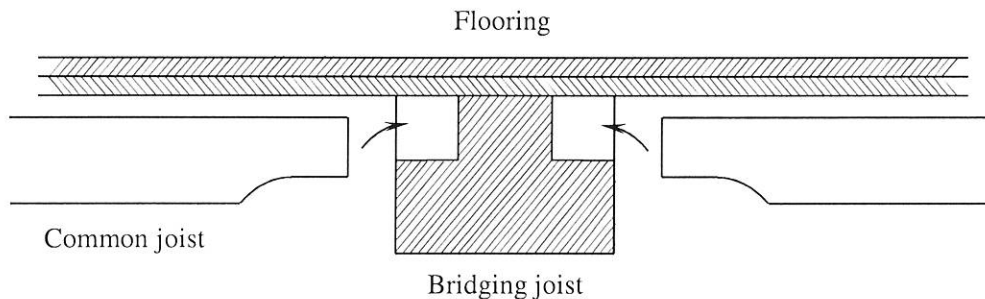

The front and rear wall plates of the frame appear to be white pine (*Pinus strobus*). They are hewn, and measure approximately 7 inches in height and 6 inches in depth (thickness). The posts that support the plates are also 6 inches in depth above the second floor (below, right).

The knee-wall construction of the house employs relatively simple carpentry joints. In general, the joining of wall and roof structural members does not make use of the complex joints that characterized “English” houses from the 1600s until after 1800.⁸

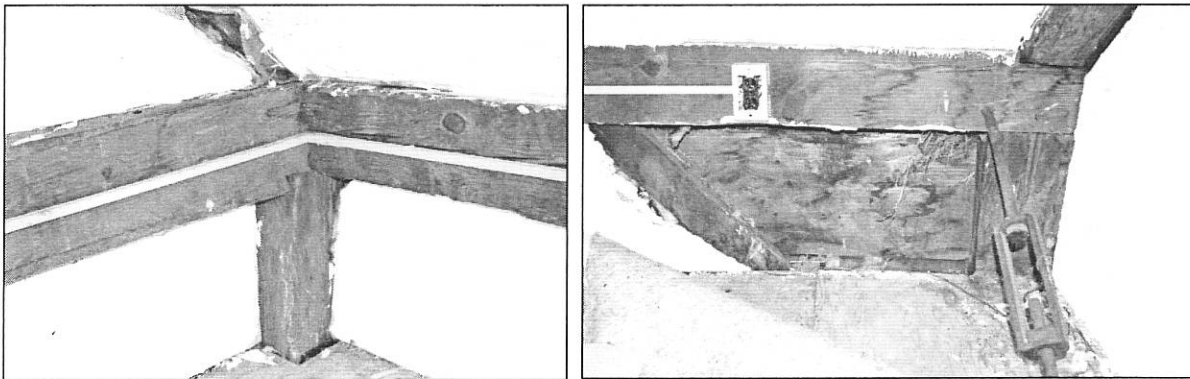

Left: Corner joint of knee-wall frame, showing juncture of corner post, wall plate, tie beam (left), and rafter.

Right: Middle joint of knee-wall frame, showing juncture of wall post, wall plate, and rafter, with added iron turnbuckle to resist spreading of the wall. A brace is visible at the left.

⁸ For seventeenth-century origins of “English” framing practices in New England, see Abbott Lowell Cummings, *The Framed Houses of Massachusetts Bay, 1625-1725* (Cambridge, Mass.: Harvard University Press, 1979). For later “English” framing and framing in other traditions, see Jack Sobon, *Historic American Timber Joinery: A Graphic Guide* (Beckett, Mass.: Timber Framers Guild, 2002).

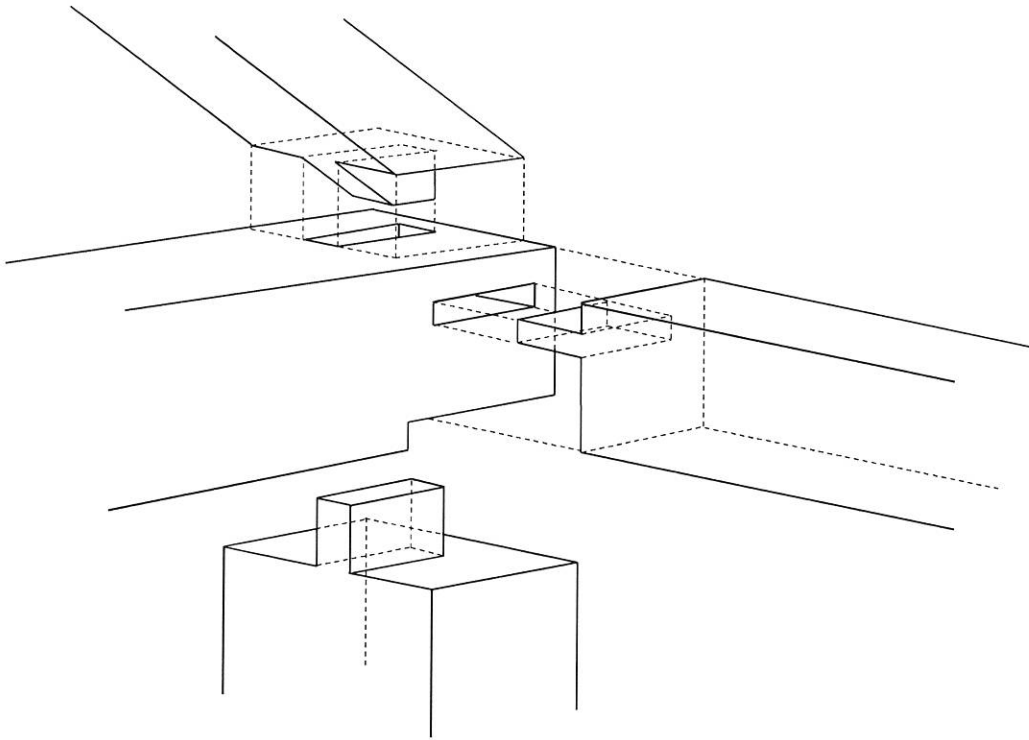

Above: exploded diagram of framing joints at a corner of the building based on visual details seen in the photograph on the previous page, left. Below: exploded view of rafter seat and wall post tenon.

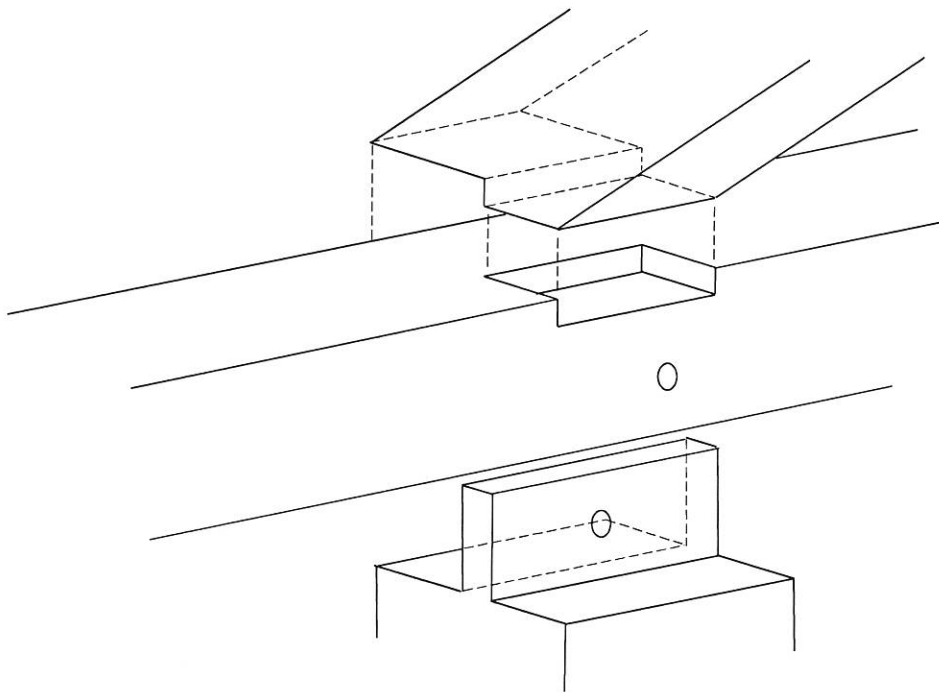

The drawing at the bottom of the previous page shows an unusual seat for the rafters that rest on the wall plates at the four inner posts of the front and rear walls. This insubstantial notched seat provides insecure anchorage for the feet of the rafters. There may be a hidden detail that adds some strength to the rafter seats, such as a pin (treenail) driven diagonally through the feet of the rafters into the wall plates, but it cannot be detected in places where the rafter feet were rotated upward by the lifting of the roof planes when the ridge was raised. As nearly as can be determined, the rafters were laid out as shown below. The rafters are hewn, and measure approximately 6 inches deep by 5½ inches wide.

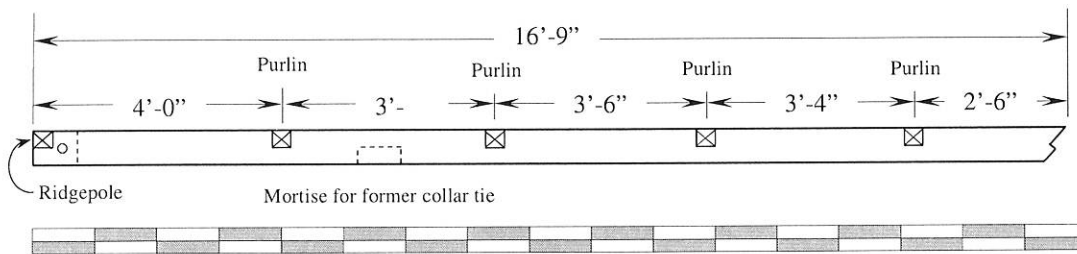

Rafter layout, Holmes House

The anchorage of the rafter feet at the top of the front and rear wall plates, without a tenon anchored more deeply within the plates, exerted a twisting or overturning force on the plates. The tendency for the plates to twist outward, or for the walls to spread at the top, may have been seen as increasingly troublesome when the roof planes were raised and the expanse of the roof was enlarged by the addition of new construction above the old ridge elevation, as shown on page 7. Probably at the time of the wholesale remodeling of the house circa 1850, wrought iron turnbuckles were inserted in the two central structural units of the house. These were intended to link the tops of the front and rear wall plates and the bridging joists below by means of devices that could be tightened by turning the hand-forged turnbuckle. Although hand fabricated, these pieces of hardware do not appear to be ancient; the threads appear to be machine-made rather than cut by the blacksmith.



Left: Typical turnbuckle installed to link wall plates (top) with beams below (one of four).

Dating the Frame: As noted above, the Holmes House has undergone several remodelings that have removed most of its datable stylistic features and left only the frame as a largely intact architectural feature. It is nearly impossible to date a building frame unless there is a context for the frame that allows the carpentry to be placed in a datable sequence. In the case of the Holmes House, there is no known equivalent to its knee-wall design except in houses dating from the period after circa 1830. The only intact dwelling to share similarities of the floor framing system of the Holmes House is the Seaborn Mary (Mary Wilson Wallace) House from Londonderry,

which was moved from its place or origin to Little Compton, Rhode Island, in 1937, as mentioned on page 4. Yet that house and the Holmes House have notable differences in design and layout, making the Seaborn Mary House only partially an equivalent to the Holmes House.

The best hope for determining the age, and hence the significance, of the Holmes House is through dendrochronology. Dendrochronology uses datable sequences of annual growth rings in structural timber to determine the period of time through which the tree grew. To determine the construction date of a structure it is necessary to ascertain when the trees that were used in the framing were felled. To determine that, it is important 1) to have a species of wood for which tree-ring sequences have been worked out and 2) to have timbers for sampling that retain the cambium layer, which lies just under the bark. The cambium is the layer of living cells, which divide each summer to form new wood and a visible new tree ring. If tree ring sequences have been worked out for a given species of timber, it may be possible to date the portions of the tree that are retained in the hewn or sawn timber of a building by matching the tree rings in the timber to known sequences. But if the cambium layer is not present, it is not possible to determine the year in which the tree was felled and, hence, the approximate date of the building. The presence of the cambium layer is most easily detected by the retention of tree bark on a timber. Fortunately, several of the heavy bridging joists of the Holmes House, presumed to be eastern white pine, retain the cambium of the trees from which they were hewn, as do a few of the smaller common joists, believed to be white oak.

William Flynt of Historic Deerfield in Massachusetts has become a leading authority and proponent of dendrochronological dating of buildings. In May 2005, Historic Deerfield hosted a wide-ranging conference on dendrochronology. The papers that were delivered at that conference have been made available on a compact disk under the title of "Tree-Ring Dating in the Northeast: Dendrochronology and the Study of Historical Forests, Climates, Cultures, and Structures." This compact disk is available from the Historic Deerfield Museum Store at:

<http://www.historic-deerfield.org/museum-store/online-store/books-music/cdsdvds/>

Most dendrochronological research has focused on white and red oak in Massachusetts, which may make it feasible to date those oak common joists in the Holmes House that retain the original outer surface of the wood.

Christopher Baisan of the University of Arizona Laboratory of Tree-Ring Research has made a long-term practice of coming to southeastern Vermont for a few weeks each summer. There, he has developed tree-ring sequences for several of the tree species that grow in our zone of New England. A description of Professor Baisan's professional (not his Vermont avocational) dendrochronology can be seen at:

<http://ltr.arizona.edu/people/baisan>

When I corresponded with Professor Baisan some years ago, he expressed a willingness to come to Bath, New Hampshire, on the upper Connecticut River, to try to date a covered bridge of circa 1829. That never worked out, but I suspect that if he still comes to Vermont in the summer, he would be intrigued with the possibility of getting involved with an early house in New Hampshire.

If the Londonderry Historical Society wishes to pursue dendrochronological dating of the Holmes House, and if circumstances permit this after expiration of the demolition delay period for the structure, I would be happy to try to investigate other potential sources of help for this effort.

APPENDIX



NEW HAMPSHIRE DIVISION OF HISTORICAL RESOURCES

State of New Hampshire, Department of Cultural Resources
 19 Pillsbury Street, 2nd floor, Concord NH 03301-3570
 Voice/ TDD ACCESS: RELAY NH 1-800-735-2964
<http://www.nh.gov/nhdhr>

603-271-3483
 603-271-3558
 FAX 603-271-3433
preservation@nhdhr.state.nh.us

GRANITE SPLITTING TOOLS AND TECHNIQUES

By about 1800, stonecutters in many parts of New England had perfected the basic techniques of finishing and shaping granite. These craftsmen were not only able to split large slabs and posts from boulders, but had also learned to use hammers and chisels to shape the stone to a wide variety of forms, including steps, thresholds, curbs, lintels, columns, watering troughs, and rainwater basins.

In the years just before 1830, a new granite splitting method was introduced. Each method of splitting granite leaves distinctive marks at the edge of the stone, and these marks reveal whether a given piece of granite was quarried or split before or after about 1830—useful knowledge in dating a building or a stone object.

Prior to about 1830, the procedure for splitting granite entailed the cutting of a line of shallow slots in the face of the stone, using a tool called a cape chisel, struck with a heavy hammer. Small, flat steel wedges were placed between shims of sheet iron and driven into these slots, splitting the stone. The new splitting method of circa 1830 used a “plug drill,” which had a V-shaped point and was rotated slightly between each blow of the hammer, creating a round hole two or three inches deep.

Plug drill for cylindrical hole
 Cape chisel for flat slot

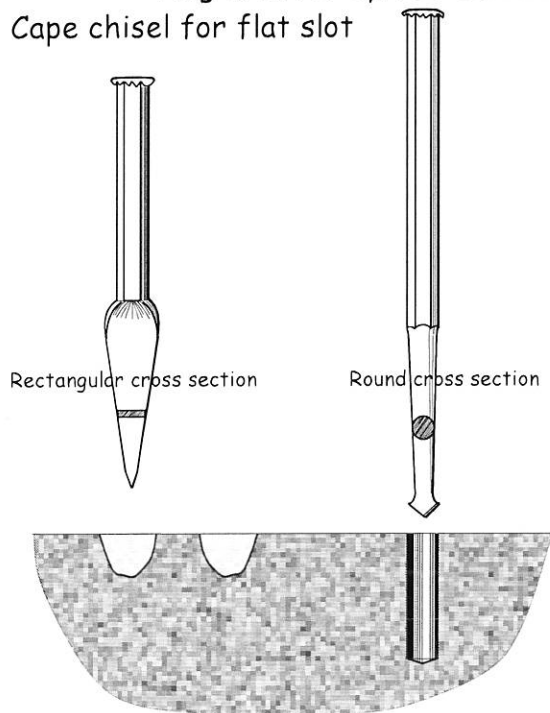

Into this hole were placed a pair of half-round steel shims or “feathers,” and between these was driven a wedge or “plug” which exerted outward pressure and split the stone. The advantage of the “plug-and-feathers” method of splitting was the greater depth within the stone at which the wedges exerted their pressure, thus allowing larger pieces to be split more accurately.

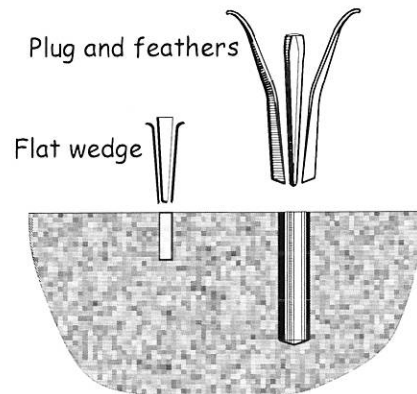

The new splitting technology seems to have spread rather rapidly through the granite quarrying centers of New England, although one is likely to find evidence of both old and new methods being used concurrently in stonework of the 1830s, especially in rural areas. The technique employed on a given stone can usually be seen on the split face, and provides some aid in dating granite masonry. The old, flat-wedge method is marked by a series of slot-like depressions which extend inward an inch or so from the edges of the split stone. The plug-and-feathers method leaves a row of rounded holes, two or three inches deep and usually about six inches apart.

When seen on the surface of a stone that was prepared for splitting but never split, these slots or holes appear as shown below:

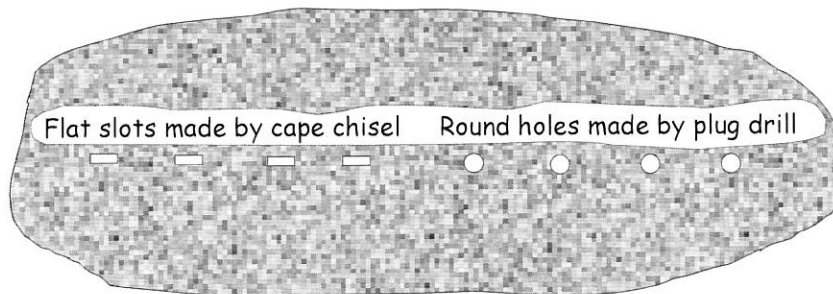

The use of the plug drill in combination with the plug-and-feathers provided greater force and control in splitting granite. Until the introduction of the new technique, most granite for buildings and posts was split from surface boulders that had been strewn across the New England landscape at the retreat of the glaciers. Such stone had been transported by the ice from many points of origin, and each boulder challenged the stonecutter with different grain and behavior when split.

The introduction of the plug drill and plug-and-feathers seems to have enhanced stonecutters' ability to quarry granite from ledges. Ledge stone was more uniform in nature and predictable in behavior than granite split from surface boulders. With the opening of early quarries at ledges in Quincy, Chelmsford, and Rockport, Massachusetts; Concord, New Hampshire; and many locations in Maine, Vermont, and Rhode Island, New England began to assume its prominent place in the American and international granite industry.

James L. Garvin
State Architectural Historian